



markilux 990

The compact markilux cassette awning - small, practical and functional



markilux 990

The compact markilux cassette awning - small, practical and functional

- design features**
- Appealing overall appearance thanks to the torque bar-free construction and especially compact cassette, 125 mm in height
 - Created by renowned designers.
 - The special cassette shape surrounds the roller tube even when the awning is extended so lending an overall harmonious appearance.
 - for long-lasting attractiveness the awning has been powder coated.
 - awning covers made from acrylic yarns or sunsilk SNC with self-cleaning effect.

- technical highlights**
- When the awning is closed the folding arms are protected behind the front profile.
 - Front profile with integrated gutter and hidden water drainage spouts.
 - The 85 mm roller tube ensures the highest rigidity and the best possible cover winding characteristics even at the largest widths.
 - Folding arms with perfected power transference by means of a round, steel-link chain.
 - Folding arms with drop-forged aluminium moving components and Teflon-coated bronze bushes, which provide superior stability and longevity.

- optional accessories**
- In the case of manual operation ease of use is ensured with the spring-assisted gearbox.
 - Hard-wired motor drive (optionally with automatic controls) for simple, relaxed operation.
 - Radio-controlled motor with handheld transmitter for ease of operation - and ergonomically crafted for ease of use.
 - An easily connected radio-controlled sun and wind sensor guarantees comfort and protection even during your absence.
 - Wall sealing profile to cover the gap between awning and wall.

- The panel joints of the awning cover are ultrasonically bonded to give a better appearance without bothersome stitching
- Manual operation includes a markilux stainless steel winding handle - quality to get to grips with
- The greater upper to lower arm length ratio ensures high lateral stability in the awning
- The use of cam bolts makes fine-tuning of the folding arms a simple procedure
- Awning available in non-standard RAL colours
- Available with a valance



pitch adjustment in the case of face fixture from 5° to 35°, in the case of top/eaves fixture from 5° to 70°



markilux 990 with wall sealing profile (optional)



Top fixture



side view at a pitch of 35°



Face fixture



side view showing gearbox eye for manual operation (standard)



folding arm with round, steel-link chain



sectional view



side view during extension

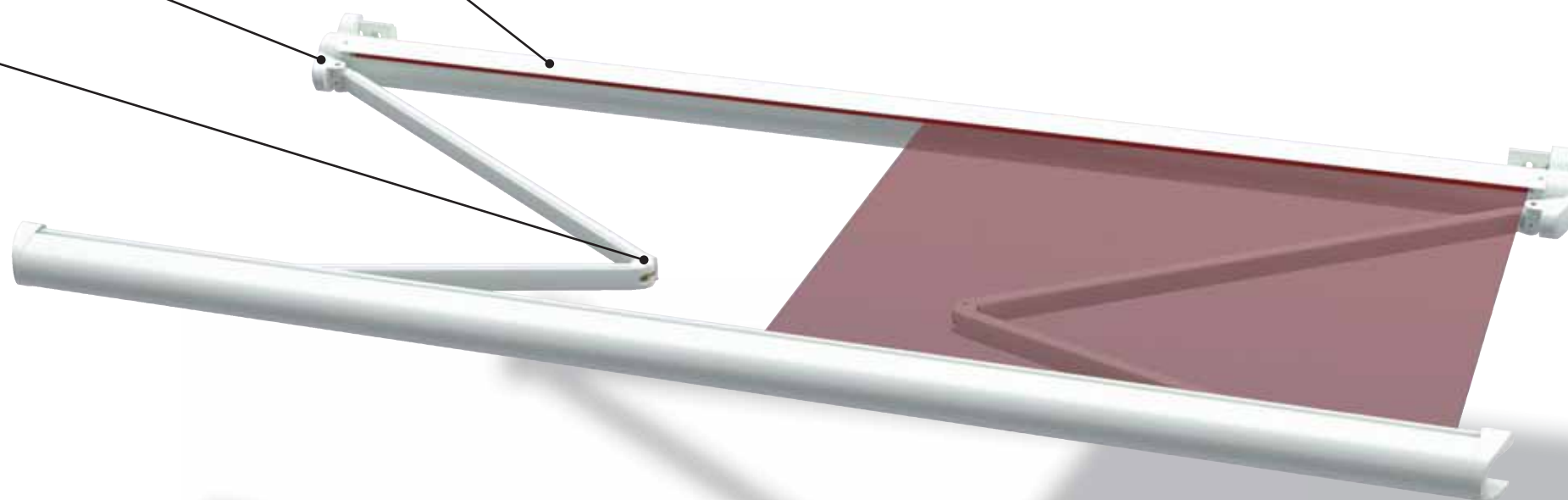

Standard RAL colours:



standard:

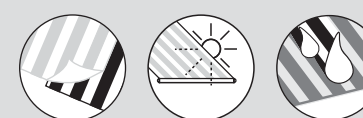

optional accessories:





markilux 990 Lounge

frame colours	End cap insert colours
Nano off-white textured finish 5233	Nano off-white textured finish 5233
Nano stone grey metallic 5215	Nano stone grey metallic 5215
Nano anthracite metallic 5204	Nano anthracite metallic 5204
	Polished chrome



markilux 990

The compact markilux cassette awning - small, practical and functional



dimensions and configuration options

extension	Overall blind width						minimum width motor ¹⁰⁾		minimum width manual operation ¹⁰⁾	
	250 166-250	300 251-300	350 301-350	400 351-400	450 401-450	500 451-500	Standard	Bespoke arms	Standard	Bespoke arms
150	28)						179	166	179	166
200	28)						229	216	229	216
250		28)					279	266	279	266
300			28)				329	316	329	316

 = available, 2 folding arms

10) the dimensions are only valid for fixture without spreader plates (2 folding arms).

dimensions in cm

28) Please note the minimum widths!

Due to the compact awning construction and depending on the width and the arm length, contact between cover and folding arms may occur during extension and retraction. This does not affect the functionality or longevity of the awning.

operation type	
manual operation with st. steel winding handle	●
Servo-assisted operation	○
radio-controlled motor	○
motor	○
Shadeplus	
manual operation	-
radio-controlled motor	-
motor	-
Lighting	
Halogen Spotlights	-
Fluorescent lighting	-
covers	
acrylic 34 (fabric series 341xx-347xx)	●
sunsilk SNC (fabric series 324xx/329xx)	●
signature (fabric series 369xx)	●
transilk FR (fabric series 319xx)	-
transolair (fabric series 339xx)	-
widely woven acrylic (fabric series 349xx)	○
perla FR (fabric series 374xx/379xx)	○
Soltis 92	-
PVC fabric	-
miscellaneous	
Coverboard	-
Sytem coverboard	-
wall sealing profile	○ ³⁾
Pitch adjustment gear	-
Insertable side blind	-
sun and wind sensor	○
Valance	○
Infrared heater	○
Vibrabox / Sunis sun sensor	○
Coupled units (please refer to fixture)	
coupled unit 2 fields	-
coupled unit 3 fields	-
junction roller	-
one-piece cover (on request)	-

● = fitted as standard

○ = optional accessory

- = not available

○³⁾ = wall sealing profile effective up to an awning pitch of 35°







● = valance shape 1 (please refer to the section "Fabric Collection")

Definition of extension: The extension is measured with the awning extended at a pitch of approx. 15° from the wall over the cover to the leading edge of the front profile. The extension tolerance is - 40mm / + 40mm

In the case of manual operation, assume approx. 16 winding handle revolutions per metre of awning extension.

Extension when using a motor takes approximately 12 seconds per metre.

Coupled folding-arm awnings are not available.

frame colours		
	RAL 9016 traffic white	●
	RAL 8019 grey brown	●
	RAL 9006 metallic aluminium	●
	5204 Nano anthracite metallic 5204 (Lounge)	○
	5215 Nano stone grey metallic 5215 (Lounge)	○
	5233 Nano off-white textured finish (Lounge)	○
	non-standard RAL colour	○

fixings and accessories

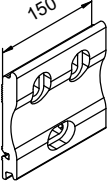
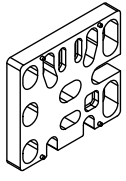
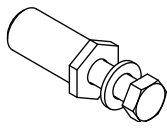
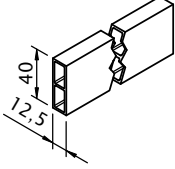
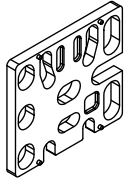
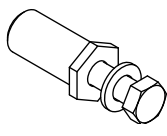
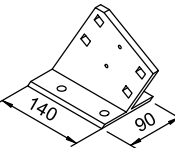
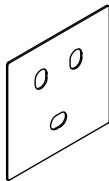
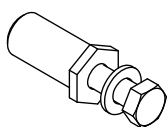
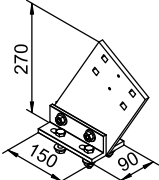
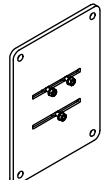
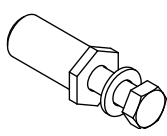
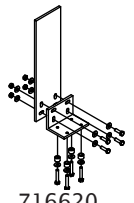
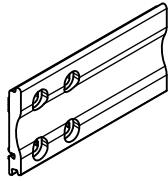
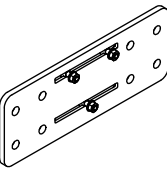
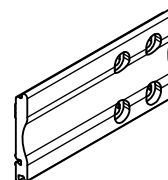
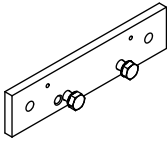
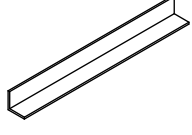
 <p>150</p> <p>Face/Top fixture bracket</p> <p>150mm</p> <p>71624.</p>	 <p>Spacer plate face/ top fixture</p> <p>136x150x20mm N.B! stack to a max. of 200 mm</p> <p>716331</p>	 <p>reducing bolt assembly M 16 - M 12 / SW 27</p> <p>50mm length (please refer to "Technical Information")</p> <p>753891</p>
 <p>40</p> <p>12.5</p> <p>stand-off strip for wall sealing profile</p> <p>available by the metre Fixture example, see face fixture with wall sealing profile</p> <p>751971</p>	 <p>Spacer plate face/ top fixture</p> <p>136x150x12mm</p> <p>71644.</p>	 <p>reducing bolt assembly M 10 - M 10 / SW 27</p> <p>50mm length (please refer to "Technical Information")</p> <p>754901</p>
 <p>140</p> <p>90</p> <p>Eaves fixture bracket</p> <p>140mm</p> <p>71612.</p>	 <p>Cover plate for external insulation</p> <p>190x190x2mm</p> <p>71636.</p>	 <p>reducing bolt assembly M 12 - M 10 / SW 27</p> <p>50mm length (please refer to "Technical Information")</p> <p>754911</p>
 <p>270</p> <p>150</p> <p>90</p> <p>Eaves fixture bracket assembly</p> <p>270mm</p> <p>71659.</p>	 <p>Component assembly spreader plate B</p> <p>300x400x12mm</p> <p>75325.</p>	 <p>reducing bolt assembly M 16 - M 10 / SW 27</p> <p>50mm length (please refer to "Technical Information")</p> <p>754921</p>
 <p>716620</p> <p>Angle and fixture plate for eaves fixture</p> <p>machine finish</p>	 <p>Face fixture bracket 300mm "left"</p> <p>70617.</p>	
 <p>75326.</p> <p>Spreader plate B (incl. bracket bolts)</p> <p>160x430x12mm</p>	 <p>Face fixture bracket 300mm "right"</p> <p>70600.</p>	
 <p>75383.</p> <p>Additional eaves fixture plate</p> <p>60x260x12mm</p>	 <p>Angled profile for eaves fixtures</p> <p>100x100mm available by the metre, undrilled</p> <p>79380.</p>	

. = Please insert the RAL No. (please refer to the section on "Coatings")

Face fixture

Pull-out force [N=Newton] per fixture point according to EN 13561, wind resistance class 2

H [cm]	compression-proof substrate						non compression-proof substrate					
	M [cm]						M [cm]					
	250	300	350	400	450	500	250	300	350	400	450	500
150	464	536	609	681	754	826	598	691	785	878	972	1065
200	753	867	980	1093	1207	1320	971	1117	1263	1409	1555	1701
250	---	1229	1391	1554	1716	1879	---	1584	1793	2003	2212	2422
300	---	---	1876	2096	2316	2536	---	---	2418	2702	2985	3269
HT BHT	2 150 mm						2 150 mm					
BM	6						6					

The pull-out force refers to the vertical centre to centre measurement between the fixture points of 90 mm. If this measurement is reduced, the pull-out force increases by 14% in the case of **compression-proof** substrates and by 19% in the case of **non-compression-proof** substrates.

- M = overall awning width
- H = extension
- FB = pull-out force per fixing point
- HT | BHT = bracket quantity | width
- BM = no. of fixing points
- WA = wall sealing profile

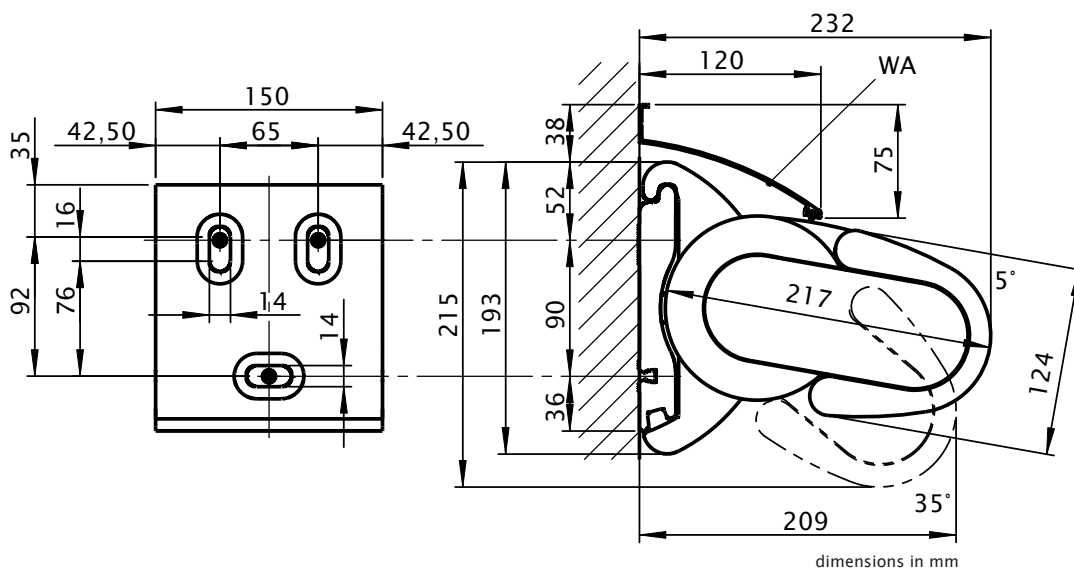

Face fixture with spreader plate A

Pull-out force [N=Newton] per fixture point according to EN 13561, wind resistance class 2

H [cm]	compression-proof substrate						non compression-proof substrate					
	M [cm]						M [cm]					
	250	300	350	400	450	500	250	300	350	400	450	500
150	252	292	331	370	410	449	358	414	470	526	582	638
200	408	470	531	593	654	716	580	668	755	842	930	1017
250	---	665	753	841	929	1017	---	945	1070	1195	1320	1445
300	---	---	1014	1133	1252	1371	---	---	1441	1610	1780	1949
HT BHT	2 150 mm						2 150 mm					
BP	2						2					
BM	16						16					

The pull-out force refers to the vertical centre to centre measurement between the fixture points of 76 mm. In the case of spreader plates a washer conforming to DIN 9021 must be used.

- M = overall awning width
- H = extension
- FB = pull-out force per fixing point
- HT | BHT = bracket quantity | width
- BP = no. of spreader plates
- BM = no. of fixing points

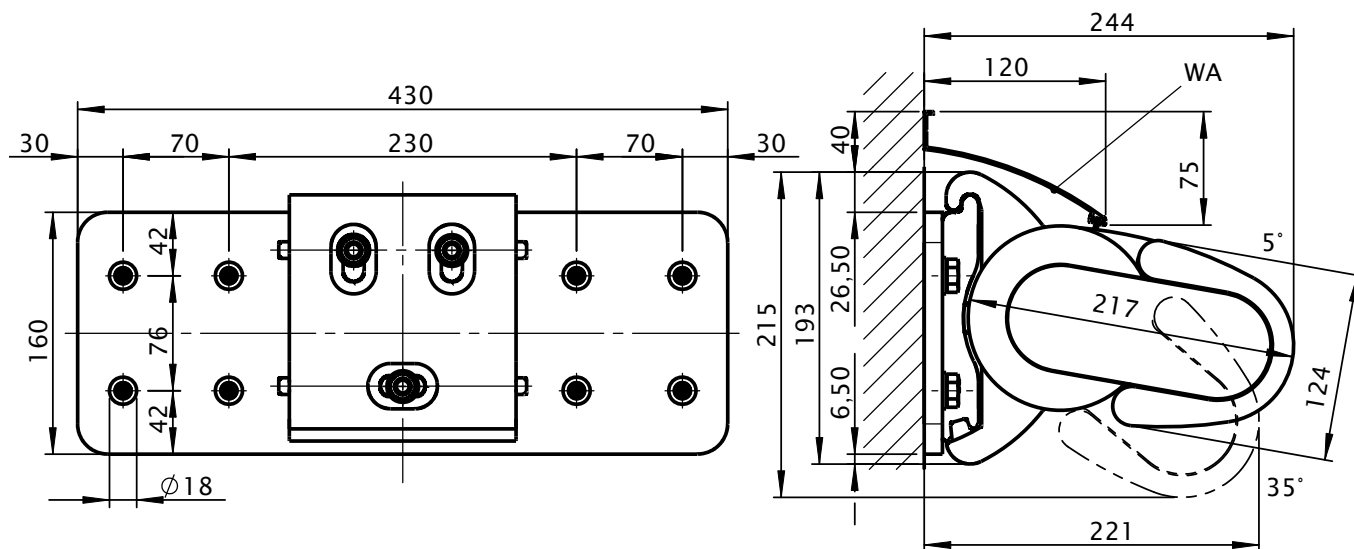

dimensions in mm

Face fixture with spreader plate B

Pull-out force [N=Newton] per fixture point according to EN 13561, wind resistance class 2

H [cm]	compression-proof substrate						non compression-proof substrate					
	M [cm]						M [cm]					
	250	300	350	400	450	500	250	300	350	400	450	500
FB [N]												
150	149	173	196	219	243	266	156	180	204	229	253	277
200	242	278	314	351	387	424	252	290	328	366	404	442
250	---	394	446	498	550	602	---	410	465	519	573	628
300	---	---	600	671	741	811	---	---	626	699	773	846
HT BHT	2 150 mm						2 150 mm					
BP	2						2					
BM	8						8					

The pull-out force refers to the vertical centre to centre measurement between the fixture points of 350 mm. In the case of spreader plates a washer conforming to DIN 9021 must be used.

- M = overall awning width
- H = extension
- FB = pull-out force per fixing point
- HT | BHT = bracket quantity | width
- BP = no. of spreader plates
- BM = no. of fixing points

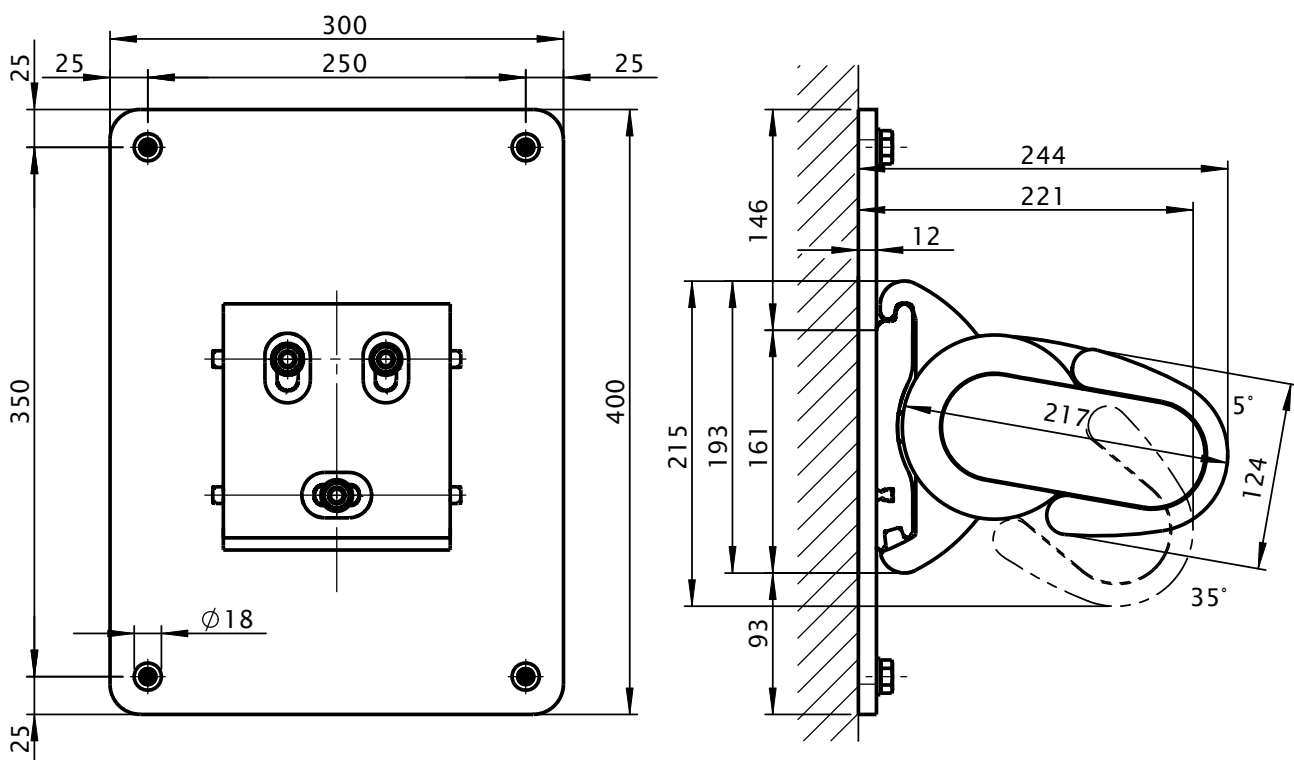

dimensions in mm

Top fixture

Pull-out force [N=Newton] per fixture point according to EN 13561, wind resistance class 2

H [cm]	compression-proof substrate						non compression-proof substrate					
	M [cm]						M [cm]					
	250	300	350	400	450	500	250	300	350	400	450	500
150	719	834	949	1064	1179	1294	735	853	970	1088	1206	1323
200	1128	1301	1474	1647	1820	1992	1155	1332	1508	1685	1862	2039
250	---	1813	2056	2298	2541	2783	---	1857	2105	2353	2601	2850
300	---	---	2741	3065	3389	3713	---	---	2808	3139	3471	3803
HT BHT	2 150mm						2 150 mm					
BM	8						8					

The pull-out force refers to the horizontal centre to centre measurement between the fixture points of 80 mm.

M = overall awning width
 H = extension
 FB = pull-out force per fixing point
 HT | BHT = bracket quantity | width
 BM = no. of fixing points

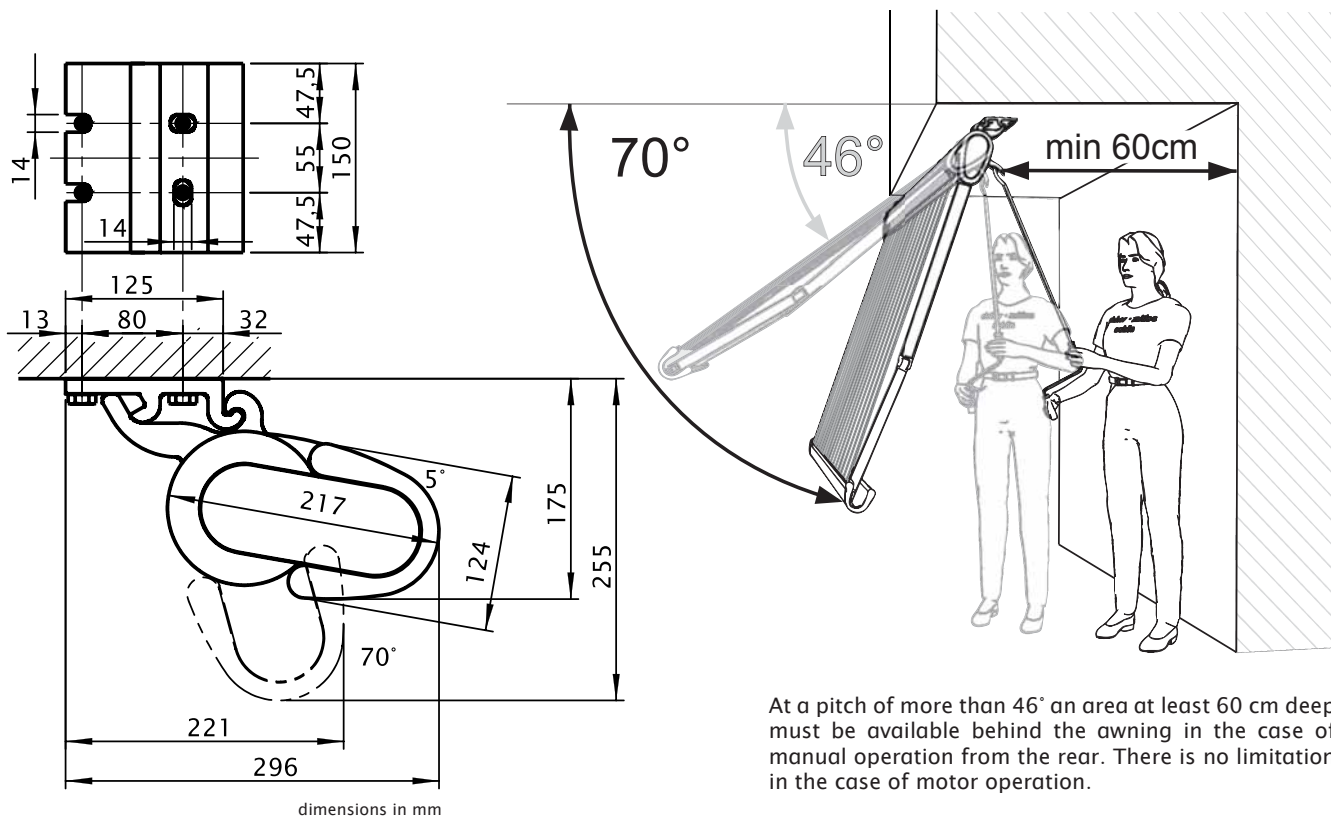

At a pitch of more than 46° an area at least 60 cm deep must be available behind the awning in the case of manual operation from the rear. There is no limitation in the case of motor operation.

Eaves/Roof timber fixture

Pull-out force [N=Newton] for the fixture bracket next to the arm according to EN 13561, wind resistance class 2

H [cm]	Torque						shear force					
	M [cm]						M [cm]					
	250	300	350	400	450	500	250	300	350	400	450	500
	Md [Nm]						FS [N]					
150	108	124	141	158	175	192	1321	1533	1745	1957	2168	2380
200	175	201	227	254	280	306	2067	2384	2701	3018	3336	3653
250	---	285	323	360	398	436	---	3317	3761	4205	4650	5094
300	---	---	435	486	537	588	---	---	5011	5603	6196	6788
HT	2						2					
BM	8						8					

The shear force are calculated from 2 fixture points per bracket, because depending on the roof pitch it cannot be guaranteed that 4 fixture points per bracket can be used.

- M = overall awning width
- H = extension
- Md = torque value for the bracket next to the arm
- FS = shear force
- HT = bracket
- BM = no. of fixing points

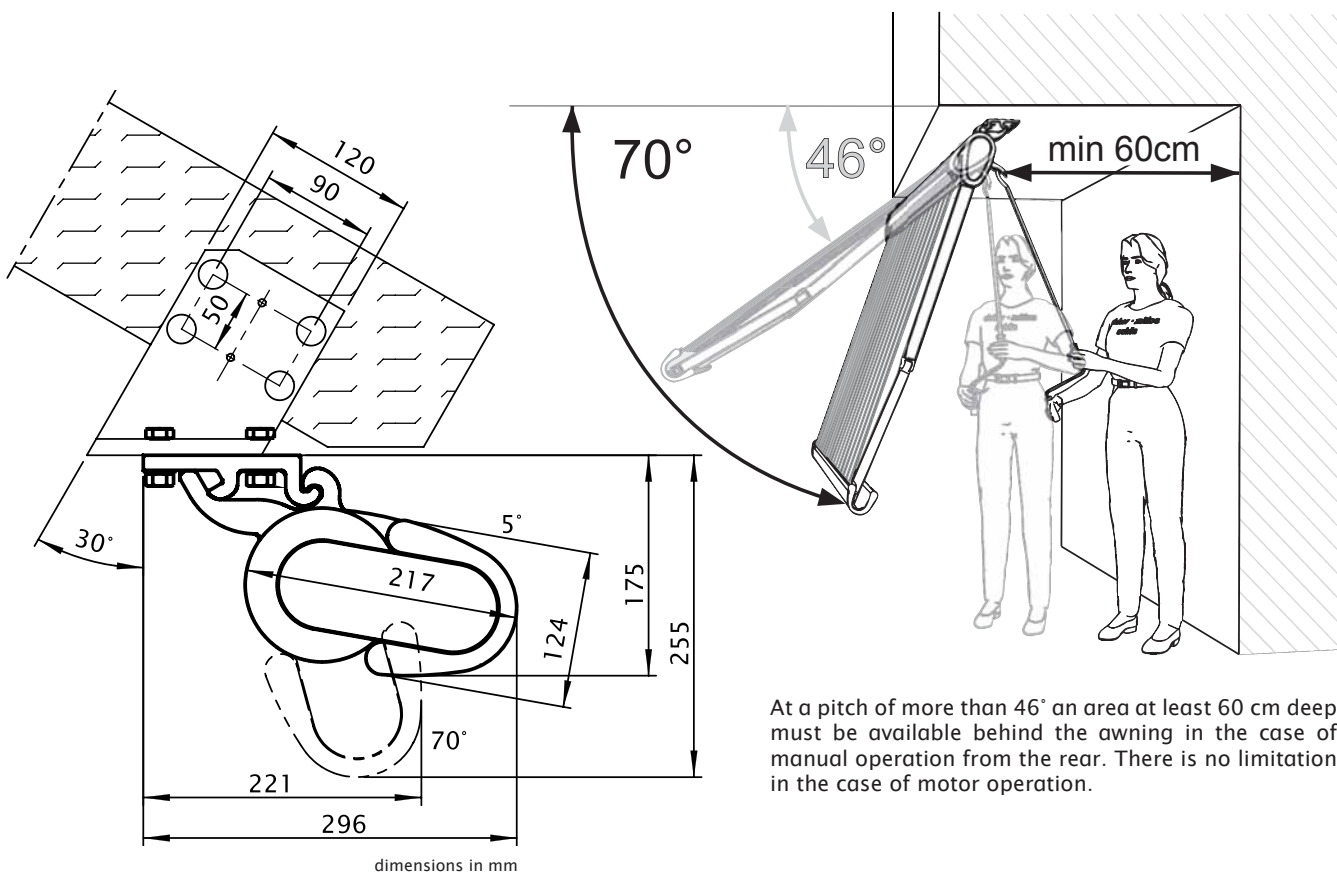

At a pitch of more than 46° an area at least 60 cm deep must be available behind the awning in the case of manual operation from the rear. There is no limitation in the case of motor operation.

Eaves fixture with additional plate

Pull-out force [N=Newton] for the fixture bracket next to the arm according to EN 13561, wind resistance class 2

H [cm]	Torque						shear force					
	M [cm]						M [cm]					
	250	300	350	400	450	500	250	300	350	400	450	500
	Md [Nm]						FS [N]					
150	108	124	141	158	175	192	663	772	881	990	1100	1209
200	175	201	227	254	280	306	999	1155	1312	1468	1625	1781
250	---	285	323	360	398	436	---	1575	1789	2002	2216	2430
300	---	---	435	486	537	588	---	---	2351	2631	2912	3192
HT	2						2					
BM	4						4					

By using the additional flat plate, the shear force is reduced in comparison with conventional eaves fixture.

M = overall awning width
 H = extension
 Md = torque value for the bracket next to the arm
 FS = shear force
 HT = bracket
 BM = no. of fixing points

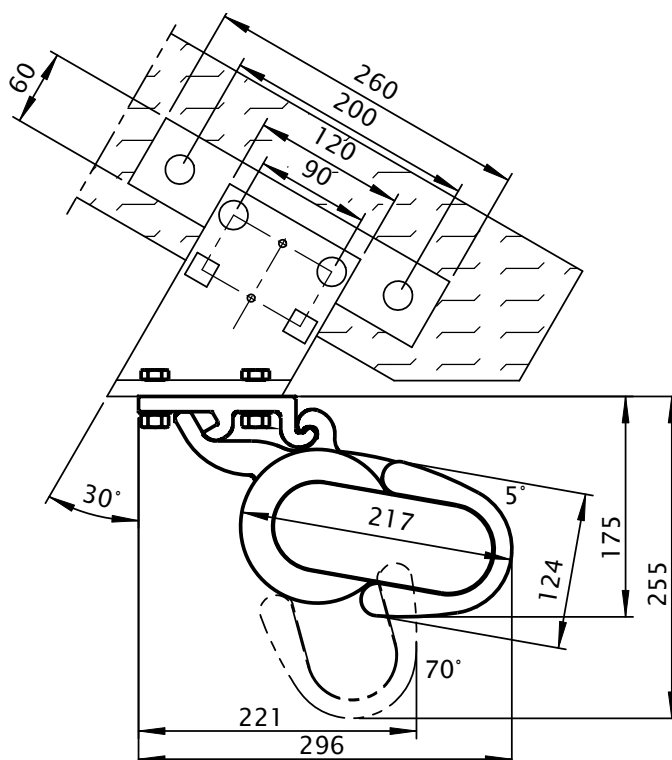

dimensions in mm

At a pitch of more than 46° an area at least 60 cm deep must be available behind the awning in the case of manual operation from the rear. There is no limitation in the case of motor operation.

Bracket range for awnings with 2 folding arms

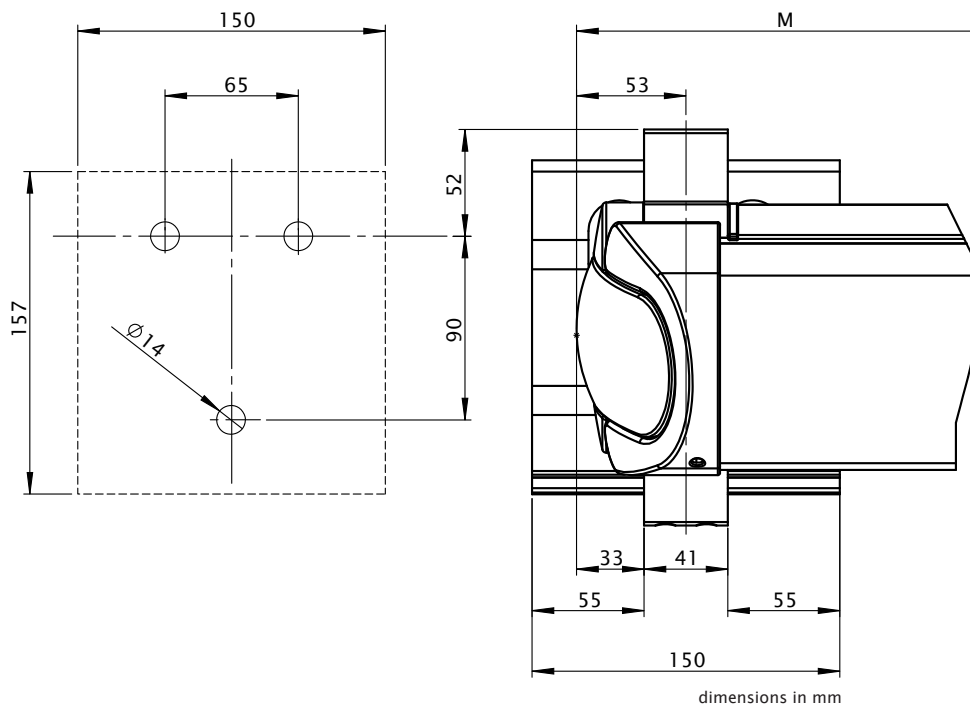
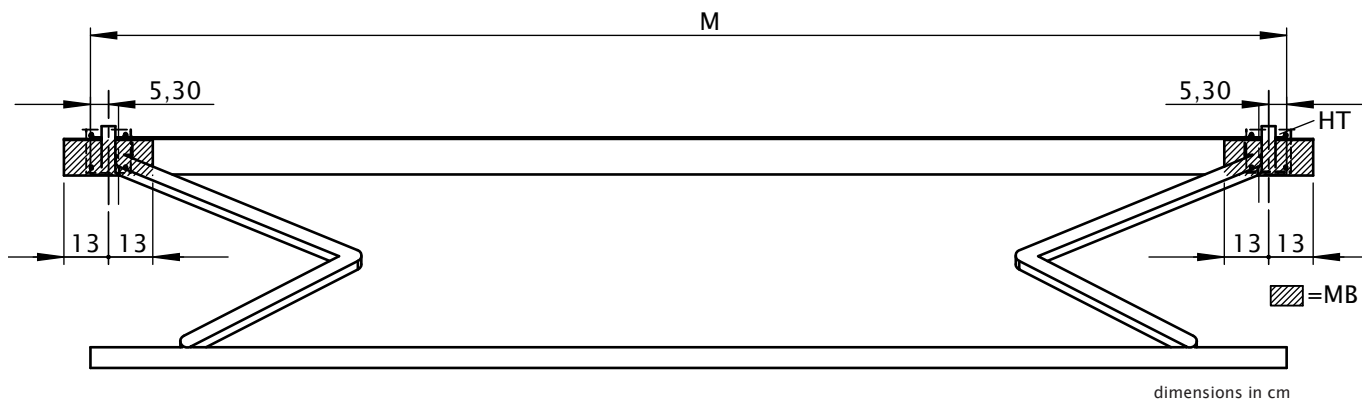

M = overall awning width
 HT = bracket
 MB = range for bracket fixture